



ELECTRIC ORBITAL SANDER INSTRUCTION MANUAL
3 in x 4 in (75 mm x 100 mm)
4,000/min – 9,000/min (OPM)
INPUT : 110-120 Va.c. 50 - 60 Hz. 150 W (350 W S2 1min)

Important Safety Information

Please read, understand and follow all safety information contained in these instructions prior to the use of this tool. Retain these instructions for future reference.

Intended Use

This electric tool is intended for use in industrial locations, and used only by skilled, trained professionals in accordance with the instructions in this manual. This electric tool is designed to be used with a disc pad and appropriate abrasive for sanding metals, wood, stone, plastics and other materials. It should only be used for such sanding applications and within marked capacity and ratings. Only accessories specifically recommended by **EKASAND** should be used with this tool. Use in any other manner or with other accessories could lead to unsafe operating conditions.

Do not operate tool in water or in an excessively wet application.

Do not use disc pads that have a Max RPM or Max OPM less than the tool Max RPM or Max OPM rating. Never use disc pads that have a weight and/or size different from what the tool was specifically designed for.

Explanation of Signal Word Consequences

 **WARNING** : Indicates a potentially hazardous situation which, if not avoided, may result in death or serious injury and/or property damage.

 **CAUTION** : Indicates a potentially hazardous situation which, if not avoided, may result in minor or moderate injury and/or property damage.

Summary of Device and Carton Labels containing Safety Information

 **CAUTION** : For safe operation, see instruction manual



Recycle: Do not dispose in household waste



Wear eye protection
Wear respiratory protection
Wear hearing protection



Read operator instructions before using

AWG

American Wire Gauge

UNC

United Coarse Thread



Technischer Überwachungsverein Rheinland United States and Canada Approved Mark



Federal Communications Commission

<p>Read the Material Data Sheets (MSDS) Before using any materials</p>  <p>Contact the suppliers of the workpiece materials and abrasive materials for copies of the MSDS if one is not readily available.</p>	<h2 style="margin: 0;">WARNING</h2> <p>Exposure to DUST generated from workpiece and/or abrasive materials can result in lung damage and/or other physical injury.</p> <p>Use dust capture or local exhaust as stated in the MSDS. Wear government-approved respiratory Protection and eye and skin protection.</p> <p>Failure to follow this warning can result in serious lung damage and/or physical injury.</p>
---	---



GENERAL POWER TOOL SAFETY WARNINGS

WARNING : Read all safety warnings and all instructions. Failure to follow the warnings and instructions may result in electric shock, fire, and/or other serious injury.

Save all warnings and instructions for future reference. The term “power tool” in the warnings refers to your mains-operated (corded) power tool or battery-operated (cordless) power tool.

1) Work Area Safety

- a) Keep work area clean and well lit. Cluttered or dark areas invite accidents.
- b) Do not operate power tools in explosive atmospheres, such as in the presence of flammable liquids, gases or dust. Power tools create sparks which may ignite the dust or fumes.
- c) Keep children and bystanders away while operating a power tool. Distractions can cause you to lose control.

2) Electrical Safety

- a) Power tools plugs must match the outlet. Never modify the plug in any way. Do not use any adapter plugs with earthed (grounded) power tools. Unmodified plugs and matching outlets will reduce risk of electric shock.
- b) Avoid body contact with earthed or grounded surfaces such as pipes, radiators, ranges and refrigerators. There is an increased risk of electric shock if your body is earthed or grounded.
- c) Do not expose power tools to rain or wet conditions. Water entering a power tool will increase the risk of electric shock.
- d) Do not abuse the cord. Never use the cord for carrying, pulling or unplugging the power tool. Keep cord away from heat, oil, sharp edges or moving parts. Damaged or entangled cords increase the risk of electric shock.
- e) When operating a power tool outdoors, use an extension cord suitable for outdoor use. Use of a cord suitable for outdoor use reduces the risk of electric shock.
- f) If operating a power tool in a damp location is unavoidable, use a ground fault circuit interrupter (GFCI) protected supply. Use of a GFCI reduces the risk of electric shock.

3) Personal Safety

- a) Stay alert, watch what you are doing and use common sense when operating a power tool. Do not use a power tool while you are tired or under the influence of drugs, alcohol or medication. A moment of inattention while operating power tools may result in serious personal injury.
- b) Use personal protective equipment. Always wear eye protection. Protective equipment such as dust mask, non-skid safety shoes, hard hat, or hearing protection used for appropriate conditions will reduce personal injuries.
- c) Prevent unintentional starting. Ensure the switch is in the off-position before connecting to power source and/or battery pack, picking up or carrying the tool. Carrying power tools with your finger on the switch or energizing power tools that have the switch on invites accidents.
- d) Remove any adjusting key or wrench before turning the power tool on. A wrench or a key left attached to a rotating part of the power tool may result in personal injury.
- e) Do not overreach. Keep proper footing and balance at all times. This enables better control of the power tool in unexpected situations.

4) Power Tool Use and Care

- a) Do not force the power tool. Use the correct power tool for your application. The correct power tool will do the job better and safer at the rate for which it was designed.
- b) Do not use the power tool if the switch does not turn it on and off. Any power tool that cannot be controlled with the switch is dangerous and must be repaired.
- c) Disconnect the plug from the power source and/or the battery pack from the power tool before making any adjustments, changing accessories, or storing power tools. Such preventive safety measures reduce the risk of starting the power tool accidentally.
- d) Store idle power tools out of reach of children and do not allow persons unfamiliar with the power tool or these instructions to operate the power tool. Power tools are dangerous in the hands of untrained users.
- e) Maintain power tools. Check for misalignment or binding of moving parts, breakage of parts and any other condition that may affect the power tool's operation. If damaged, have the power tool repaired before use. Many accidents are caused by poorly maintained power tools.
- f) Keep cutting tools sharp and clean. Properly maintained cutting tools with sharp cutting edges are less likely to bind and are easier to control.
- g) Use the power tool, accessories and tool bits, etc. in accordance with these instructions, taking into account the working conditions and the work to be performed. Use of the power tool for operations different from those intended could result in a hazardous situation.

5) Service

Have your power tool serviced by a qualified repair person using only identical replacement parts. This will ensure that the safety of the power tool is maintained.

WARNING

To reduce the risks associated with impact from abrasive product, disc pad, or tool breakup, sharp edges, hazardous downforce, rupture, vibration and noise :

- Only personnel who are properly trained should be allowed to service this tool.
- If you notice any abnormal noise or vibration when operating the tool, immediately discontinue its use and inspect for worn or damaged components. Correct or replace the suspect component. If abnormal noise or vibration still exists, return the tool to **EKASAND** for repair or replacement. Refer to warranty instructions.
- Prior to use, inspect abrasive product and accessories for possible damage. If damaged, replace with new abrasive product and accessories available from **EKASAND**.
- Only use accessories supplied or recommended by **EKASAND**.

To reduce the risks associated with vibration :

- If any physical hand/wrist discomfort is experienced, work should be stopped promptly to seek medical attention. Hand, wrist and arm injury may result from repetitive work, motion and overexposure to vibration.

To reduce the risks associated with loud noise :

- Always wear hearing protection while operating this tool. Follow your employer's safety policy or local/national standards for personal protective equipment requirements.

To reduce the risks associated with fire or explosion :

- Do not operate the tool in explosive atmospheres, such as in the presence of flammable liquids, gases, or dust. The abrasives are able to create sparks when working material, resulting in the ignition of the flammable dust or fumes.
- Refer to MSDS of material being worked as to potential for creating fire or explosion hazard.

To reduce the risks associated with ingestion of harmful / toxic dusts from sanding surfaces such as lead painted surfaces, woods and metals :

- Contact with or inhalation of these dusts can endanger the health of operator and bystanders. Use appropriate personal protective equipment.
- Use appropriate respiratory and skin protection, or local exhaust as stated in the MSDS of the material being worked on.

CAUTION

To reduce the risk associated with environmental contamination :

- Do not throw electric power tools into the household waste! In accordance with the European Directive 2002/96/CE on Waste Electrical and Electronic Equipment and transposition into national law, used electric power tools must be collected separately and recycled in an environmentally friendly manner.
- Separate collection of used products and packaging allows materials to be recycled. Use of recycled materials helps prevent environmental pollution and reduces the demand for raw materials.
- Dispose of all the process dust in accordance with all applicable regulations.

To reduce the risks associated with fly off of abrasive product or parts :

- Use care in attaching abrasive product and disc pad; following the instructions to ensure that they are securely attached to the tool before use.
- Never free spin the tool or otherwise allow it to be started unintentionally.
- Never point this product in the direction of yourself or another person, or start tool unintentionally.
- Never over-tighten accessory fasteners.

Parts List

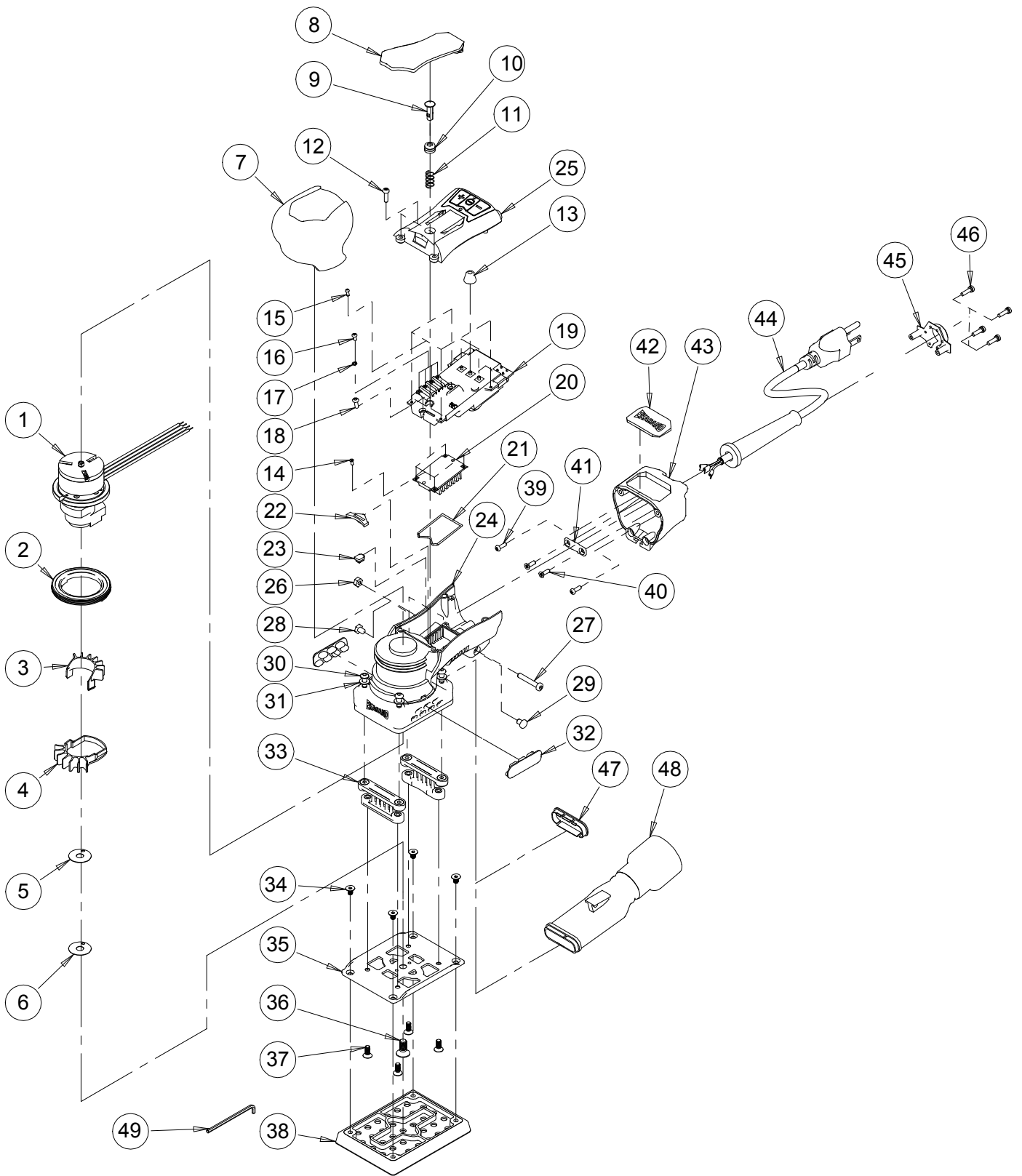

Parts List

Item	P/N	Description	QTY.
1	EOS40014-1	Motor Assembly 3"x4" (1/8")	1
2	XP10	Lock Ring Assembly	1
3	EOS41011	Cooling Fan (1/8" Orbit) TOP	1
4	EOS41012	Cooling Fan (1/8" Orbit) Bottom	1
5	XPA0080	Spacer(0.4T)	1
6	XPA0079	Spacer(0.2T)	1
7	EOS32023	Grip	1
8	EOS40024	Lever for EKASAND 9,000 OPM e-ROS (1/8") Orbit 110-120V	1
9	EOS30042	Valve Stem Assembly	1
10	EOS50102	Dust Cover	1
11	EOS50129	Spring	1
12	S4-3012B	Button Head Screw (M3x12)	2
13	EOS50206	Button Fastener	3
14	S5-2005B	Hex Socket Headless Set Screw (M2x5)	4
15	S7-2006A	Button Head Screw (M2x6)	2
16	S6-2505A	Socket Button Head Cap Screw (M2.5x5)	4
17	SW2-025A	Spring Washer	4
18	S6-3008A	Socket Button Head Cap Screw (M3x8)	2
19	EOS40019	Printed Circuit Board Controller (110-120V)	1
20	EOS51121	Heat Sink	1
21	EOS30141	Dust Seal	1
22	EOS30142	Cord Support	1
23	EOS40141	Plug	2
24	EOS42030	Machined Housing	1
25	EOS32024	Machined Housing Cover	1
26	HN2-04CA	Hex. Nut (M4)	1
27	XPA0512	Socket Button Head Cap Screw (M4x25)	1
28	EOS50145	Plug	1
29	EOS50146	Plug	1
30	XPA0768	Hex Socket Button Head Machine Screw (M4x12)	4
31	XPA0076	Washer(M4)	4
32	EOS40021	3x4 in. Side Cover	2
33	EOS40017	Mini PAD Support (3"x 4")	2
34	XPA0766	Hex Socket Countersunk Head Machine Screw (M4x6)	4
35	XPB0101	Machined 3x4" Pad Backing For Fastener Mounted Pads	1
36	XPA0078	Socket Flat Counter Sunk Machine Screw (M6x14)	1
37	XPA0767	Hex Socket Countersunk Head Machine Screw (M4x10)	4
38	N/A	1 Pad Supplied With Each Tool	OPT
39	S4-3010B	Button Head Screw (M3x10L)	2
40	S5-3010B	Hex Socket Headless Set Screw (M3x10)	2
41	EOS50105	Cord Support Plat	1
42	EOS50175	Logo Insert	1
43	EOS31018	End Cap	1
44	EOS50174-I12	Power Cord Assembly	1
45	EOS50104	SR Clamp	1
46	B2-0310A	Set Screw (M3x10)	4
47	EOS40023	Snap-IN VAC Cover Plate	1
48	EOS32022	CV Swivel Exhaust Fitting (1")	1
49	XPA0864	2.5mm Hex Wrench	1

Product Configuration / Specifications : Electric Orbital Sander

Pad Size mm(in.)	Vacuum Type	Orbit mm(in.)	Voltage	No.	Model	Product Net WT. Kg(lb.)	Height mm(in.)	Length mm(in.)	Noise Level dBA Pressure (Power)	Uncertainty K	Vibration Level m/s ² (ft/s ²)	Uncertainty K m/s ²
75x100 (3x4)	Non Vacuum	3.0(1/8)	110-120V	1	E2-40N30U	1.12 (2.47)	106 (4.17)	186 (7.32)	61.3 (72.3)	3dB	4.58 (15.03)	1.5
	Central Vacuum	3.0(1/8)	110-120V	2	E2-40C30U	1.17 (2.58)	106 (4.17)	219 (8.64)	61.1 (72.1)	3dB	4.75 (15.58)	1.5
75x100 (3x4)	Non Vacuum	3.0(1/8)	220-240V	3	E2-40N30E	1.12 (2.47)	106 (4.17)	186 (7.32)	63.8 (74.8)	3dB	4.93 (16.17)	1.5
	Central Vacuum	3.0(1/8)	220-240V	4	E2-40C30E	1.17 (2.58)	106 (4.17)	219 (8.64)	62.0 (73.0)	3dB	4.97 (16.31)	1.5

IMPORTANT NOTE

The noise and vibration values stated in the table are from laboratory testing in conformity with stated codes and standards and are not sufficient risk evaluation for all exposure scenarios. The actual exposure values and amount of risk or harm experienced to an individual is unique to each situation and depends upon the surrounding environment, the way in which the individual works, the particular material being worked, work station design, as well as upon the exposure time and the physical condition of the user. **EKASAND** cannot be held responsible for the consequences of using declared values instead of actual exposure values for any individual risk assessment.

Operating Instructions

PRIOR TO THE OPERATION

The tool is intended to be operated as a hand held tool. It is always recommended that while using the tool, operators stand on a solid floor, in a secure position with a firm grip and footing. Be aware that the sander can develop a torque reaction.

STARTING AND STOPPING SANDER

1. Plug-in the sander's AC power cord to the power source (110-120Va.c. output). The warning "beep" sounds would be occurred after the plug is securely plug-in to the power source and the LED indicator shows "Solid Red" color at the moment.- see figure 1.
2. Press the power on/off button "⊖" on the button plate to switch on the sander. The LED indicator shows "flash green" color after sander being switched on. - see figure 2.
3. Adjust the speed by pressing "+" or "-" buttons on the button plate. Press "+" is to raise up to higher speed setting, "-" is to lower the speed setting. - see figure 3.
4. Press the lever to start running the tool. Release the Lever to stop the tool.

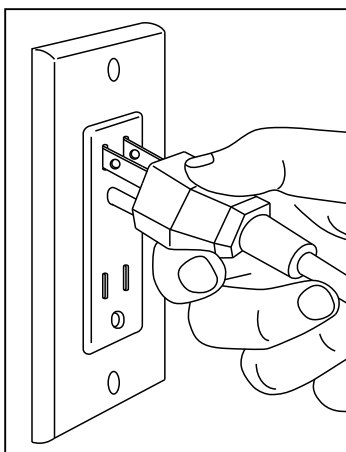

figure 1

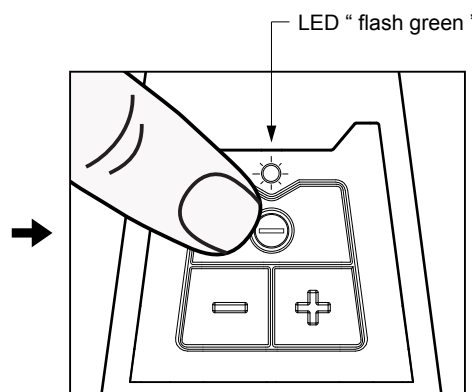

figure 2

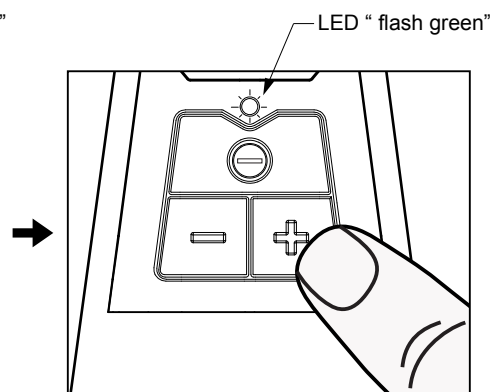

figure 3

MAXIMUM SPEED FUNCTION

The Electric Orbital Sander has **three** preset Maximum Speeds (4,000, 7,000, 9,000 r/min (OPM))
The Maximum Speed can be changed at any time while the Sander is running or when it is stopped.
Any setting for the Maximum Speed will be stored while the Power is turned "OFF".

MAXIMUM SPEED AND INTERMEDIATE SPEED CONTROL

1. Maximum Speed is adjusted by pressing the "+" or "-" buttons on the buttons plate of the Sander. Each touch will raise or lower the speed to the next setting.
2. Intermediate speeds between Zero (0)/min (OPM) and the set Maximum Speed can be used with intermediate Lever positions.- see figure 4.

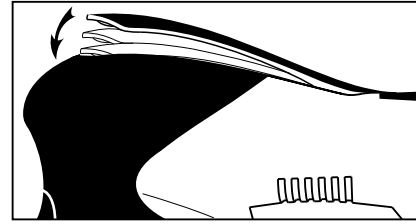

figure 4

OVERLOAD PROTECTION SYSTEMS

The Electric Orbital Sander has two systems to protect the motor and circuit board from overloading and overheating.

Downforce Overload System

The Sander has the ability to monitor and maintain the preset Maximum Speed as user downforce increases or decreases during use. During periods of overly high user downforce, the Sander will flash the LED on the back of the tool from Green to Red and cause the motor to slow slightly as a warning to the user. Continuous downforce should be no greater than approximately 11 lb. (5Kg). If the user continues with overly high downforce, the Sander will change the LED to solid Red and stop. To restart the sander immediately, released the lever and pressed down again and continue sanding. Repeated overloading will result in frequent motor stops and increased tool temperature.

Temperature Overheat System

The Sander has the ability to monitor temperature of the internal electronic systems, and can shut the tool down when temperature reach damaging levels. During periods that result in high internal temperature, the Sander will shut down if the temperature reaches a damaging level. The Sander will not be able to be restarted until the internal temperature cools to a level safe for the electronic systems. Cooling time depends on local conditions. An initial waiting period of 5 minutes is recommended. Repeated overheating will result in longer cool down times.

CLEANING

1. Periodically blow out all air passages and area above Disk Pad and under shroud with dry compressed air. All plastic parts should be cleaned with a soft damp cloth. NEVER use solvents to clean plastic parts.
2. Wear safety glasses while using compressed air.

HEALTH AND SAFETY INFORMATION

RoHS Compliant

This product and the associated component parts are "RoHs Compliant" and do not contain any of the sub stances in excess of the maximum concentration values in EU Directive 2002/95/EC, as amended by Commission Decision 2005/618/EC and other amendments issued as of the date code marked on the product.



Waste Electrical & Electronic Equipment (WEEE) Compliant

- Do not dispose of electrical appliances as unsorted municipal waste, use separate collection facilities.
- Contact your local government for information regarding the collection systems available.
- If electrical appliances are disposed of in landfills or dumps, hazardous substances can leak into the groundwater and get into the food chain, damaging your health and well-being.
- When replacing old appliances with new ones, the retailer is legally obligated to take back your old appliance for disposal at least for free of charge

Federal Communications Commission (FCC) Compliance Statement

IMPORTANT NOTE : This equipment has been tested and found to comply with the limits for a Class A digital device, pursuant to Part 15 of the FCC rules. These limits are designed to provide a reasonable protection against harmful interference when the equipment is operated in a commercial environment. This equipment generates, uses, and can radiate radio frequency energy and, if not installed and used in accordance with the instruction manual, may cause harmful interference to radio communications. Operation of this equipment in a residential area is likely to cause harmful interference in which case the user will be required to correct the interference at his own expense.

NOTICE: Changes or modifications not expressly approved by the party responsible for compliance could void the user's authority to operate the equipment.

Industry Canada Compliance Statement

This Class A digital apparatus complies with Canadian ICES-003.

Cet appareil numérique de la classe A est conforme à la norme NMB-003 du Canada.